



Futura  
71300F + 70600



Inquadra il **qr code** per visualizzare la **scheda di installazione e manutenzione**  
*Scan the qr code to read the installation and maintenance page*



Inquadra il **qr code** per visualizzare la **scheda tecnica**  
*Scan the qr code to read the technical features page*

# Futura 71300F + 70600

Porta a battente con fisso laterale + parete fissa

Pivot door with inline small panel + fix panel for corner solution

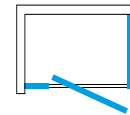

cristallo temprato 6 mm / tempered thick glass 6 mm



finiture standard / standard finishes

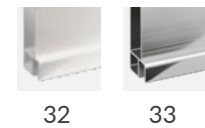

finiture speciali / special finishes

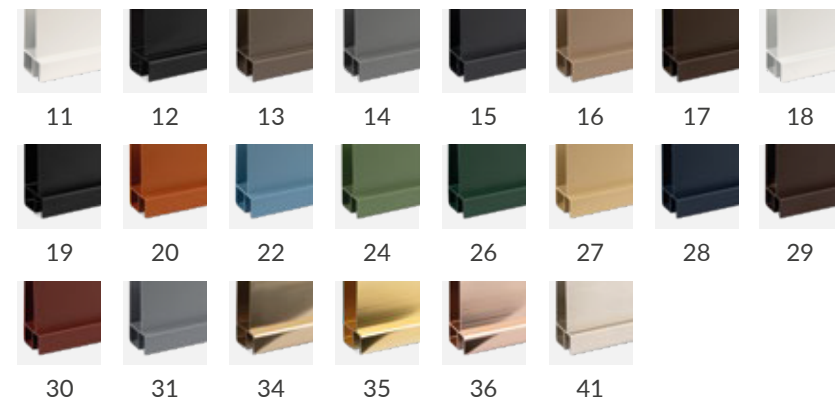

finiture speciali extra / extra special finishes

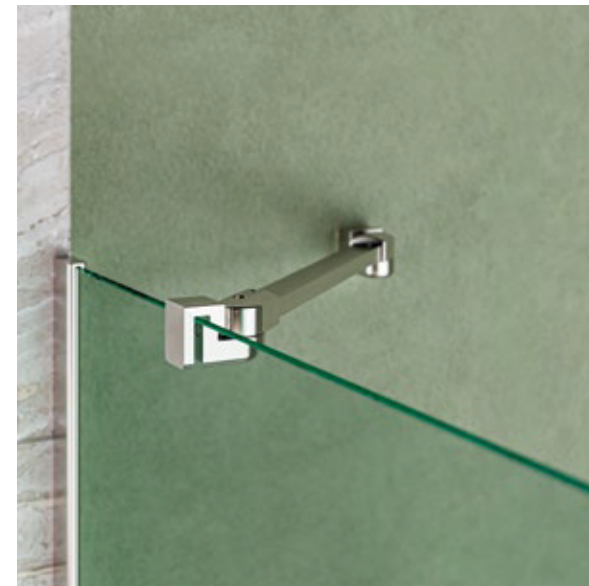
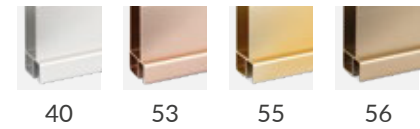

articolo article	estensione accoppiata - EST coupled extension - EST	estensione da imballo - A package extension - A	entrata (B) entry (B)	ingombro (C) encumbrance (C)	ingombro (D) encumbrance (D)	Vetro / glass		
						TR	SA	SC - FU - BR
71301F	-	97-99*	57	57	35	profili standard: Argento brill / Verniciato bianco standard profiles: polished silver (AB) / white varnished (VB)		
71302F	-	107-109*	57	57	45			
71303F	-	117-119*	57	57	55			
71304F	-	127-129*	57	57	65			
71305F	-	137-139*	67	67	65			
71306F	-	147-149*	67	67	75			
71307F	-	157-159*	67	67	85			

\* Profilo allungabile 1cm incluso  
1cm extendable profile included

articolo article	estensione accoppiata - EST coupled extension - EST	estensione da imballo - A package extension - A	entrata (B) entry (B)	ingombro (C) encumbrance (C)	ingombro (D) encumbrance (D)	Vetro / glass		
						TR	SA	SC - FU - BR
70601	-	68-70	-	-	-	profili standard: Argento brill / Verniciato bianco standard profiles: polished silver (AB) / white varnished (VB)		
70602	-	73-75	-	-	-			
70603	-	78-80	-	-	-			
70604	-	88-90	-	-	-			
70605	-	98-100	-	-	-			
70606	-	108-110	-	-	-			
70607	-	118-120	-	-	-			

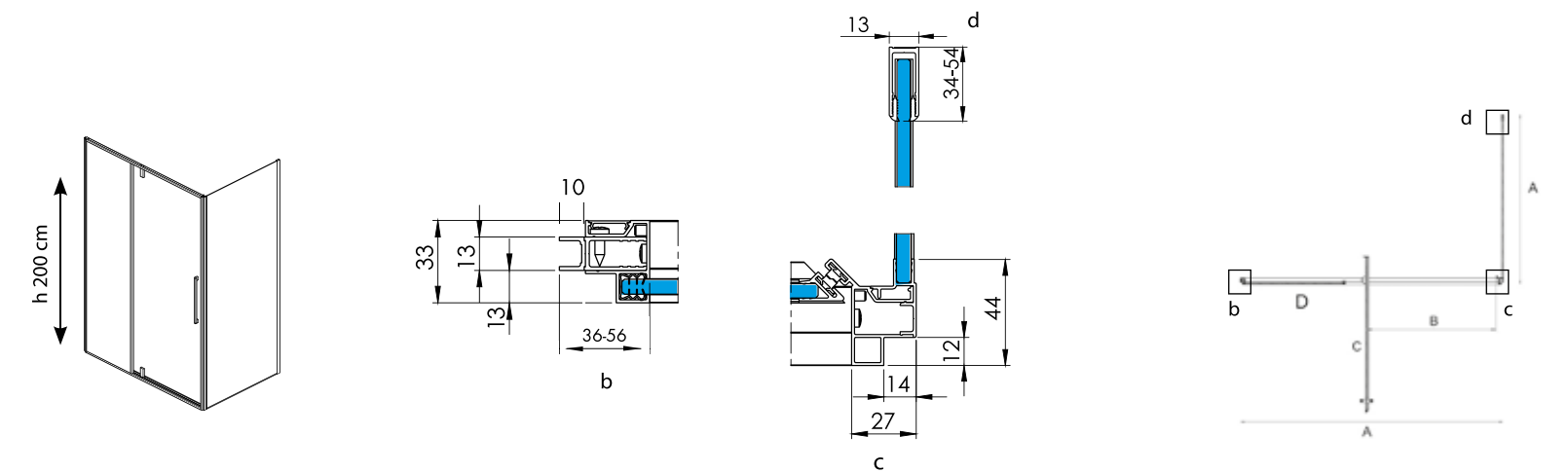

## NOTE E SUPPLEMENTI / Notes and extras

Tempi di produzione 2 settimane / 2 weeks required to manufacture

Finiture speciali: **+25%**  
Finiture speciali extra: **+50%**

Dimensioni speciali: **+25%**

Finiture speciali + dimensioni speciali: **+35%**  
Finiture speciali extra + dimensioni speciali: **+60%**

Trattamento anticalcare: per 1 lato

Special finishes: **+25%**  
Extra special finishes: **+50%**

Special size: **+25%**

Special finishes + Special size: **+35%**  
Extra special finishes + Special size: **+60%**

Anti-limescale treatment: for 1 side

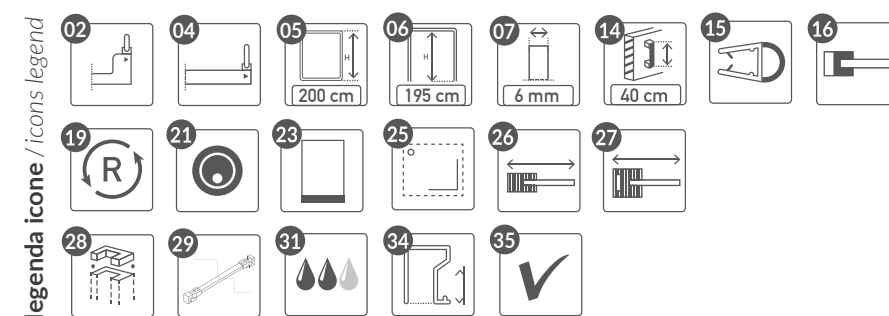

legenda icone / icons legend